

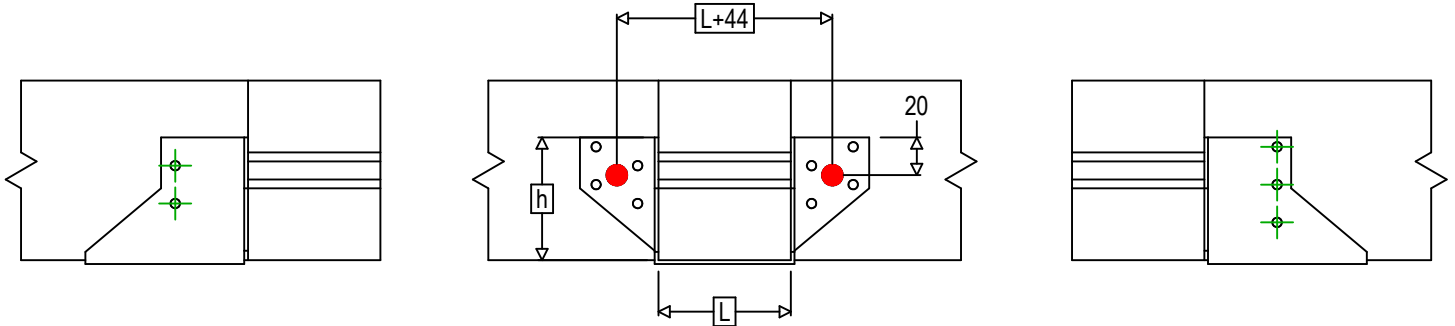

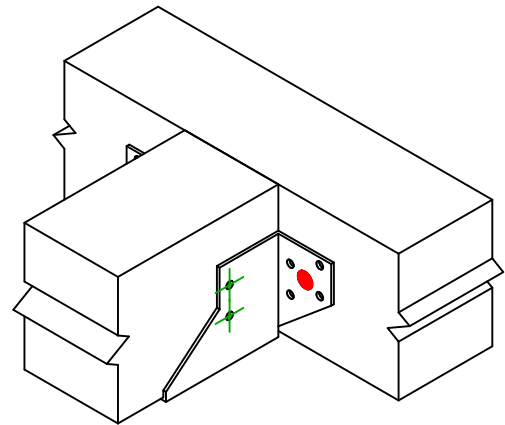





Art. Nr. =	SAE200	
Bevestigingsmiddelen =	Hout op hout	Balk op draagbalk
Type bevestiging =	Bevestiging met SSH	



$$h = (200 - L) / 2$$

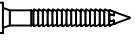

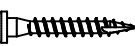
Draagbalk Bevestigingen	Symbol	Bevestigingsmiddelen	Bevestigingsmiddelen		Aantal	
	●	SSH  	SSH10.0X40			2
		-	-			
-	-					
Balk bevestiging(en)	Symbol	Bevestigingsmiddelen	L < 64mm	L > 64mm	Aantal	
	⊕	CNA  	CNA4.0X35	CNA4.0X50		5
		CSA  	CSA5.0X35	CSA5.0X40		