

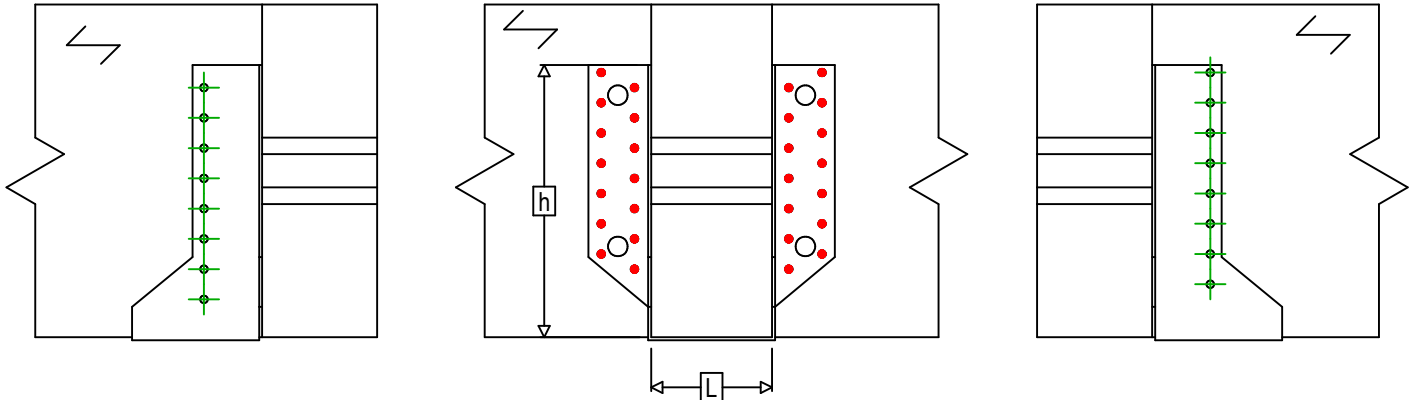

Référence =	SAEX440		
Fixations =	Bois sur bois	Solve sur poutre	
Type de fixation =	Clouage total		

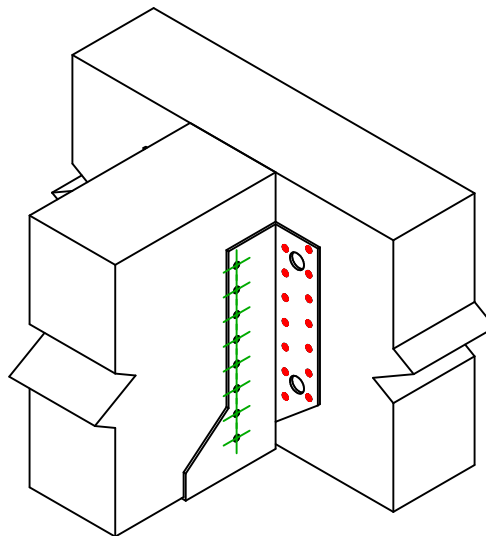

$$h = (440 - L) / 2$$



Fixation(s) Porteur	Symbole	Fixations	Fixations		Qté	
		CNAS		CNA4.0X35S / CNA4.0X50S		28
		CSAS		CSA5.0X35S / CSA5.0X40S		
-		-	-			
Fixation(s) Porté	Symbole	Fixations	L < 64mm	L > 64mm	Qté	
		CNAS		CNA4.0X35S	CNA4.0X50S	16
		CSAS		CSA5.0X35S	CSA5.0X40S	