

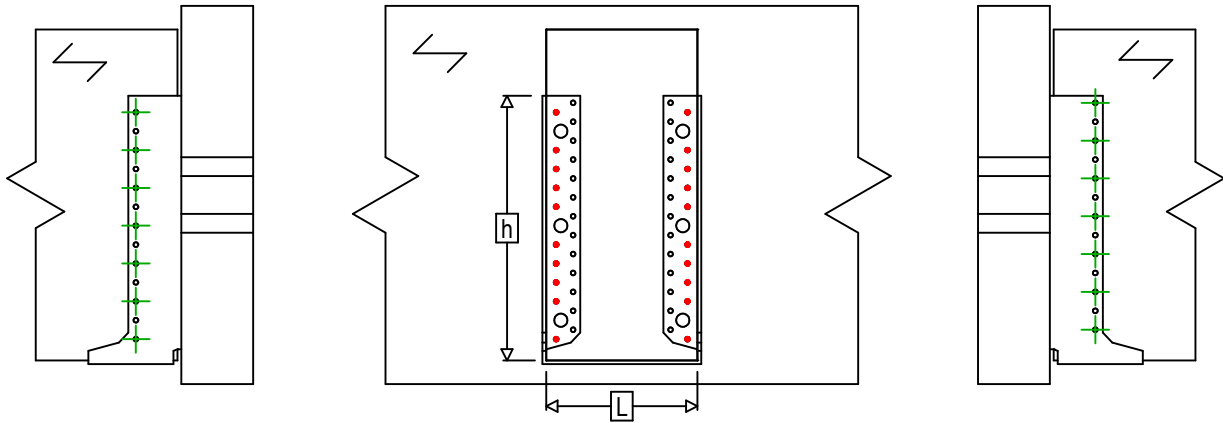

Art. Nr.	=	GLI720	
Bevestigingsmiddelen	=	Hout op hout	Balk op draagbalk
Type bevestiging	=	Gedeeltelijke vernageling	

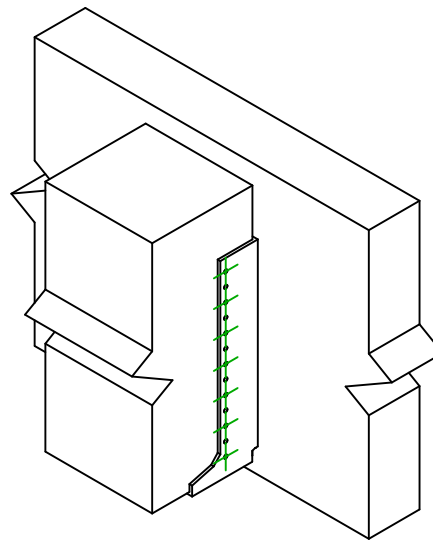

$$h = (720 - L) / 2$$



Draagbalk Bevestigingen	Symbol	Bevestigingsmiddelen	Bevestigingsmiddelen		Aantal	
		CNA		CNA4.0X35 / CNA4.0X50		20
		CSA		CSA5.0X35 / CSA5.0X40		
-		-	-			
Balk bevestiging(en)	Symbol	Bevestigingsmiddelen	L < 64mm	L > 64mm	Aantal	
		CNA		CNA4.0X35	CNA4.0X50	14
		CSA		CSA5.0X35	CSA5.0X40	